

F1-F4 AND B1-B4
DN100 DIN2632/2633
CLADDED OR RUBBERLINED

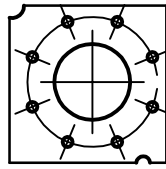

F1-F4
DN100 DIN2632/2633
UNCLADDED

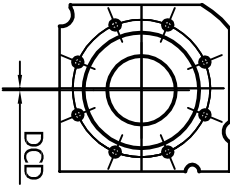

F1-F4 AND B1-B4
4 INCH ANSI CL150
DCD 2,5 MM
CLADDED OR RUBBERLINED

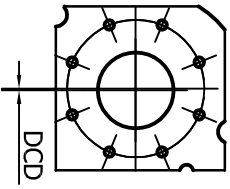

F1-F4
4 INCH ANSI CL150
DCD 2,5 MM
UNCLADDED

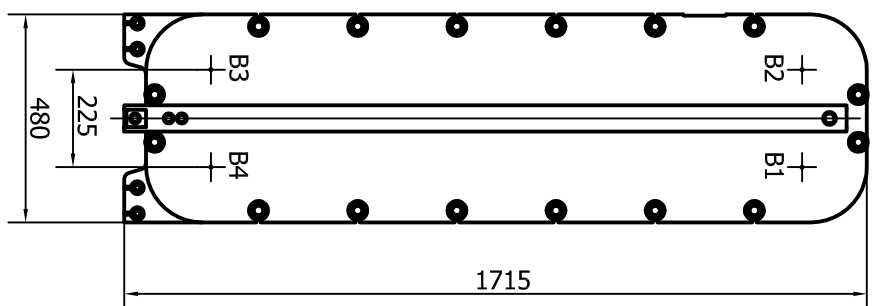
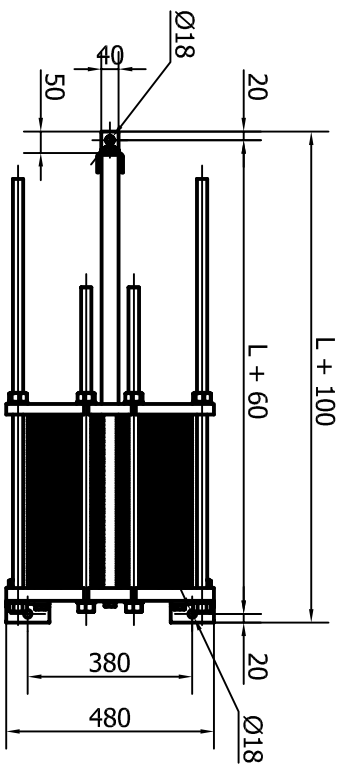
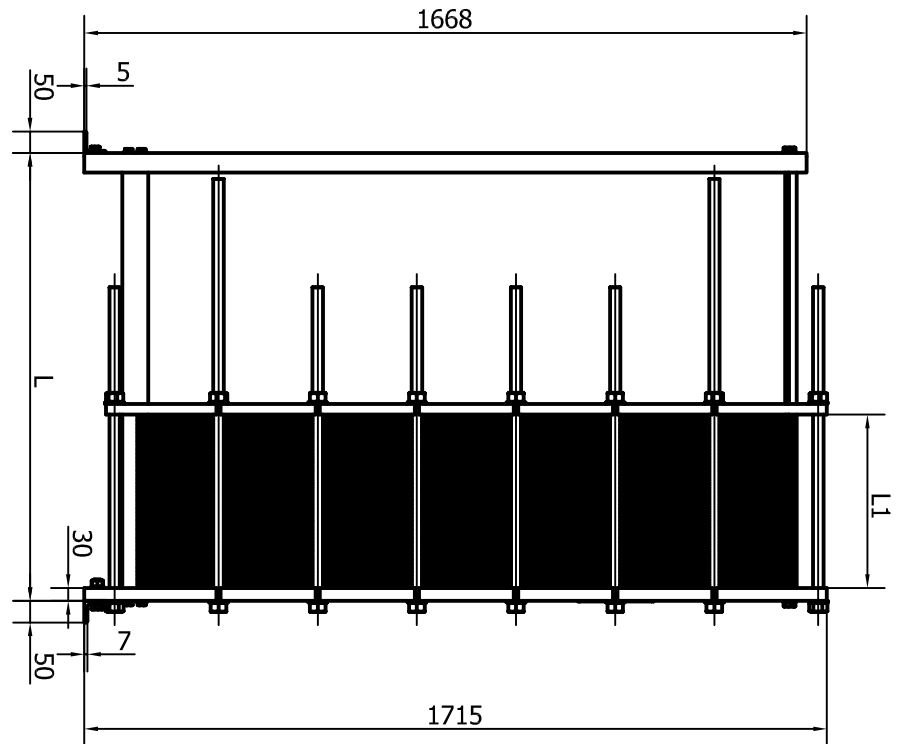
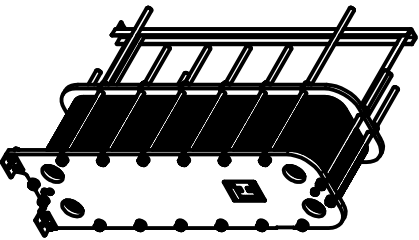
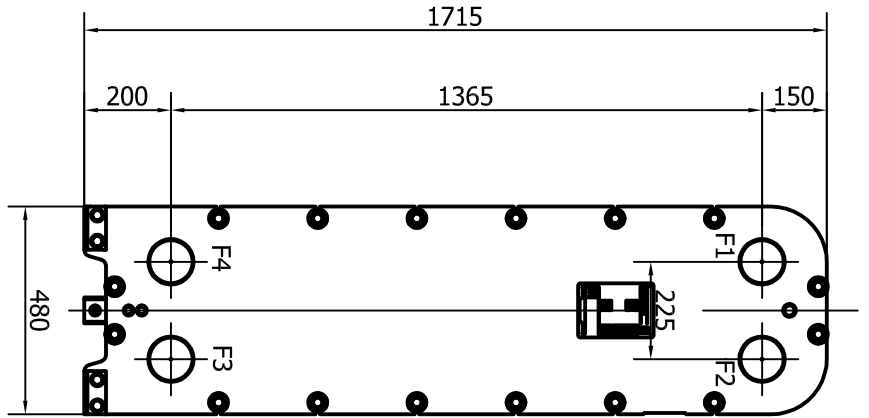

	ISO 2768-m	Dimensions without tolerance
	ISO projektion	
SONDEX Jernet 9 DK-6000 Kolding	Date: 08-11-2010 Approved by: JRD Date: 16-07-2012	Designed by: JKO Date: 08-11-2010
	Description: S47 IG PN10 DN100 DIM DRAWING LENGTH 400-1000 MM	Rev. no.: 03 Revision Text: CHANGED HEAD-FOLL-COLUMN-CARR BAR
Rev. date: 13-07-2012 Rev. by: LGK Drawing no.: S47IGPN10DN100L400-1000	Sheet: 1 / 1	