

ODWODNIENIE LINIOWE

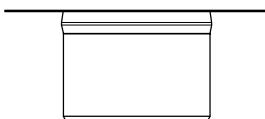
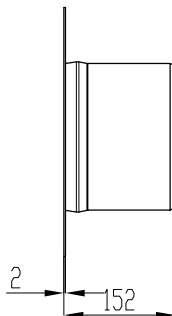
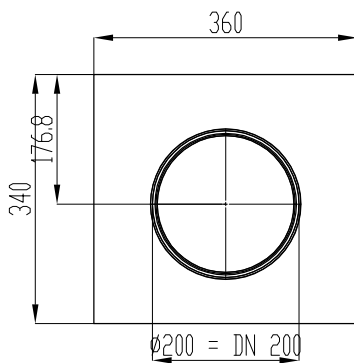
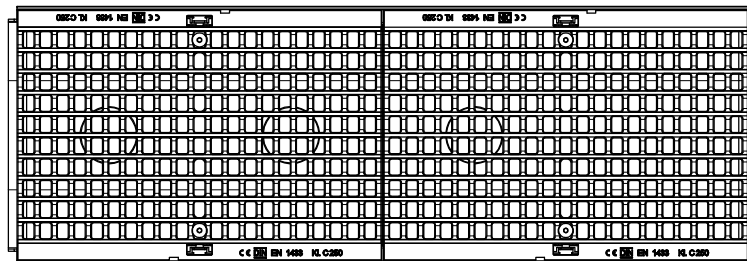
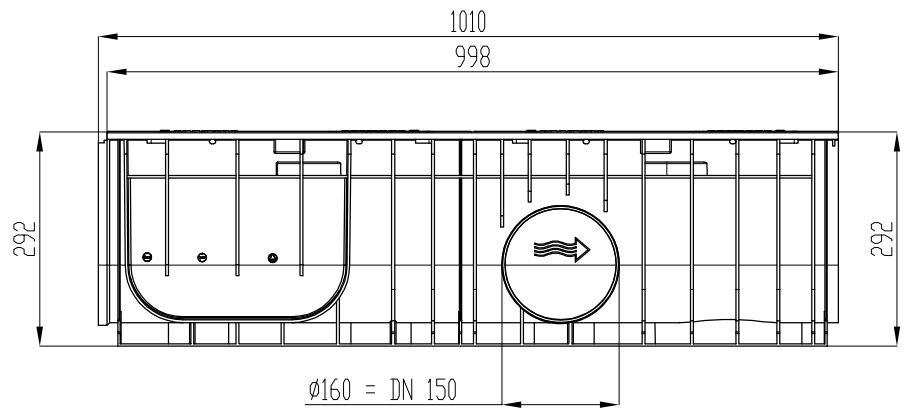
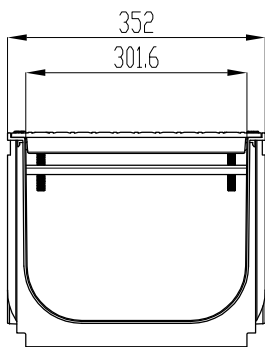
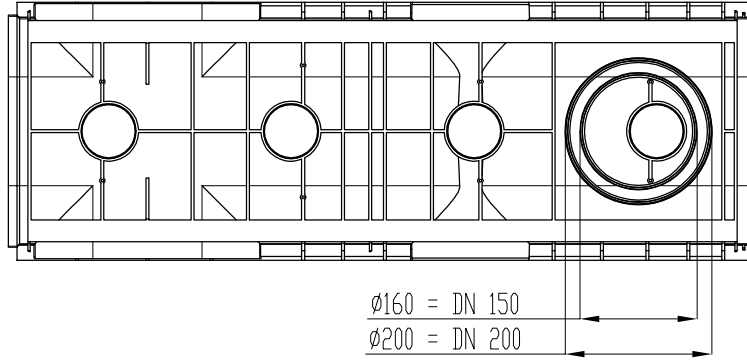

PROJEKT DROGOWIEC		PROJEKT DROGOWIEC Łukasz Milewski 15-333 Białystok, ul. Zwierzyniecka 10 lok. 7 projekt drogowiec@gmail.com tel. 505-031-332	
— ŁUKASZ MILEWSKI —			
Nazwa rysunku:	Odwodnienie liniowe	Skala:	1:500
Obiekt:	Budowa ul. H. Kollątaja, Pięknej i Ogrodowej w Suwałkach	Data:	VIII.2015.
Stadium:	Projekt wykonawczy budowy kanalizacji deszczowej	Nr rysunku:	E
Branża/Projektant:		Podpis	
SANITARNA: mgr Inż. Izabela Kozłowska PDL/0140/POOS/13 PDL/IS/0018/14			